



WIDE-AREA NOTIFICATION ACOUSTIC SIREN HORN ASH 125

For broadcasting of alarms, tones, and voice announcements

Optimum wide-area sound coverage and excellent audio quality

Various setups possible with up to 8 siren horns for any demand

Sturdy design and highest reliability

100-V transmission technology



INDUSTRONIC.COM

THE ENGINEERS OF COMMUNICATION

WIDE-AREA NOTIFICATION

POWERFUL AND FLEXIBLE

Experience the power of the ASH 125 series from INDUSTRONIC – the ultimate solution for wide-area notifications in both emergency and non-emergency situations. The cutting-edge modular acoustic siren horns are designed to deliver exceptional performance and can be deployed as classic sirens, but also allow for the output of voice announcements with superb speech intelligibility.

Crystal-clear tones and voice

With the ASH 125 series, you can broadcast crystal-clear alarm tones, live voice announcements as well as pre-recorded messages to ensure effective communication in any situation. You can also combine siren tones with voice announcements.



Customized messages and tones

Unlike traditional motor sirens with a limited preset of tones only, you have the possibility to customize your audio messages and tones, ensuring your notifications are in line with any safety policies and standards.

Modular and scalable design

The modular design of the siren horns allows for different setup options depending on your requirements and the conditions on site. Mount up to 8 siren horns on a single mast to provide extensive coverage over wide areas. Experience the ease of installation and the ability to align the horns for optimal sound projection.

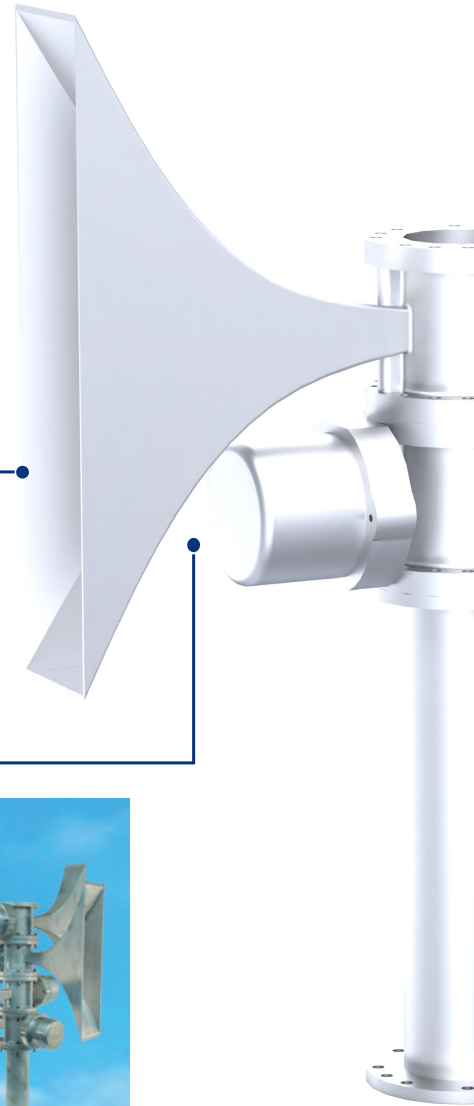

Rugged material

Our robust siren horns are built to last and constructed from marine-grade aluminum, designed to resist corrosion caused by highly aggressive seawater. Rated with up to IP66 they provide optimum protection against dust ingress and high-pressure water jets.



Highest availability

To ensure uninterrupted operation during power outages, the amplifiers driving the siren horns are optionally backed by battery systems. To further enhance availability we provide different redundancy setups up to full duplication of siren clusters in A+B configuration.



The performance of the siren horns is continuously monitored to detect and rectify any faults promptly. Diagnostics can be accessed fully remotely.

High-power driver with excellent audio quality

The 125-W midrange compression driver and the exponential diffraction horn combine exceptional performance and high-power sound distribution to meet every need.

The audio bandwidth ranges from 275 Hz to 7 kHz. When operated under full load, a siren horn is capable of producing a remarkable sound pressure level of up to 136 dB (A).

Caution! Wear ear protection when working in the vicinity of the sirens! Otherwise, you may suffer permanent hearing damage.



The siren horns are ideal for use in demanding industrial environments with high ambient noise levels.

Flexible addressing of speaker zones

Our system brings the flexibility of zoning: speaker zones can be addressed all at once or individually. This way, you can directly notify those areas which are affected in the respective situation.

Additionally, you can make use of visual signaling devices such as warning beacons to draw attention to an event.

You can also easily combine siren horns and speakers both indoors and outdoors.

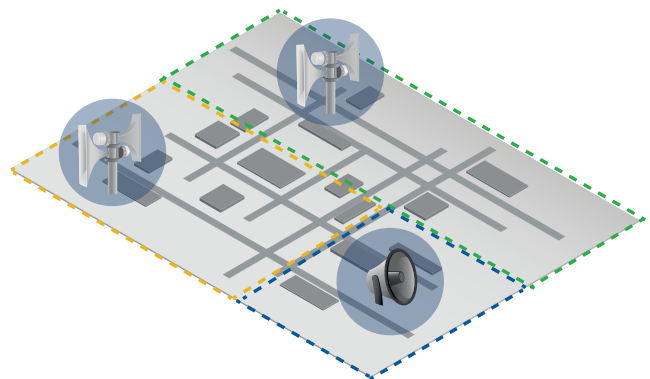

INDUSTRONIC SYSTEM SEAMLESS INTEGRATION

The acoustic siren horns can be seamlessly integrated into the communication and public address system from INDUSTRONIC. This means that you can take full advantage of the complete functional scope of the system including speaker monitoring, zone selection, power supply and redundancy concepts.

INDUSTRONIC SYSTEM

The communication and public address system excels by its wide range of functions as well as the flexible configuration possibilities to meet your application and communication requirements. Each system provides numerous interfaces for system networking, connection of external communication and control systems (e.g. fire detection and alarm systems) as well as the integration of control rooms. Furthermore, you can use different control and monitoring functions which facilitate the daily work of control room operators and service staff.

The system combines three solutions in one: It can be used as PA system to inform all persons in an industrial plant or just a specific area, as intercom system for fast and reliable process communication or as PA/GA system to effectively warn people of dangers and to give clear instructions on how to respond.

The ASH 125 series is the ideal addition to all system setups requiring wide-area sound coverage, guaranteeing exceptional performance across diverse industrial environments.

- Wide range of functions
- Numerous interfaces for system networking
- Integrated speaker and siren monitoring as well as zone selection
- Individual redundancy concepts

ONE SYSTEM - THREE SOLUTIONS

The modular and flexible system design, the extensive range of functions and the numerous interfaces enable solutions to address every communication requirement.

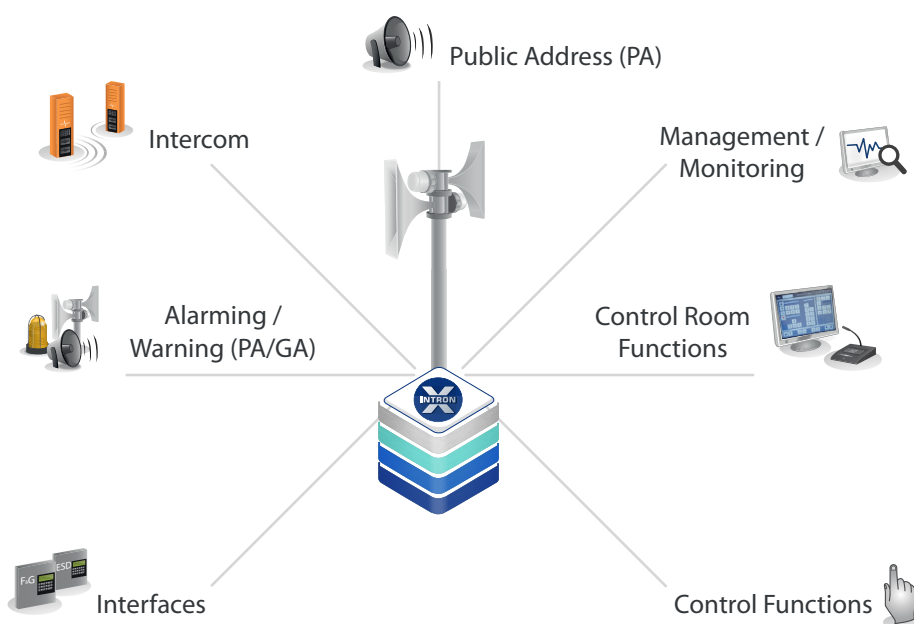

CENTRALIZED OR DECENTRALIZED SYSTEM INSTALLATION

INDIVIDUAL SOLUTIONS

Depending on your unique requirements you can choose between centralized or decentralized system installation for multiple siren cluster locations. By utilizing the 100-V transmission technology for sirens we ensure the maximum transmission range in either setup.

CENTRALIZED SYSTEM INSTALLATION

A centralized system installation is ideal for short cable runs. We recommend installing cabinets equipped with amplifiers, zone selector, line monitoring, power supply and batteries in relative proximity of the mast.

With the 100-V transmission technology longer cable distances between amplifiers and sirens of up to 1.2 km (0.62 mi) and more can be achieved with suitable cable cross-sections and tolerable power loss.

100-V system with 2 dB power loss

- 1.5 mm² cable: approx. 440 m (481 yds)
- 2.5 mm² cable: approx. 740 m (809 yds)
- 4.0 mm² cable: approx. 1188 m (0.79 mi)

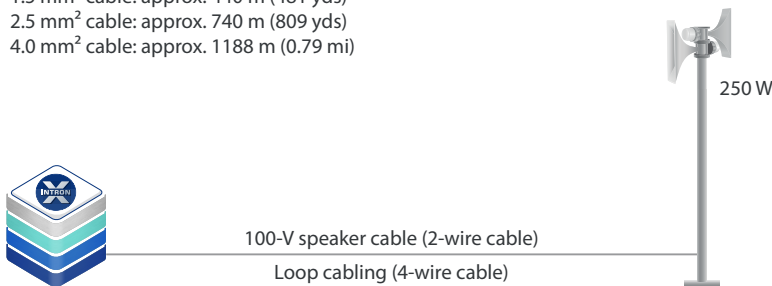

- Centralized installation for short cable runs
- Decentralized installation for wide areas and distributed systems
- Flexible installation locations for amplifiers (e.g. inside an amplifier cabinet indoors or outdoors)
- Cable length of 1.2 km (0.62 mi) possible with 4 mm² cable cross-section and max. power loss of 2 dB

DECENTRALIZED SYSTEM INSTALLATION

For wide areas or distributed systems with longer cable runs, we recommend using a decentralized system installation. Here, remote amplifier cabinets with amplifiers, controllers, batteries, power supply, etc. are installed at strategic locations near the masts, all interconnected through a common network. Our IP amplifier solutions offer an integrated approach with built-in zone selection, power supply modules, DC power supply, diagnostics and monitoring - all in one device. We also provide various redundancy options for optimum availability.

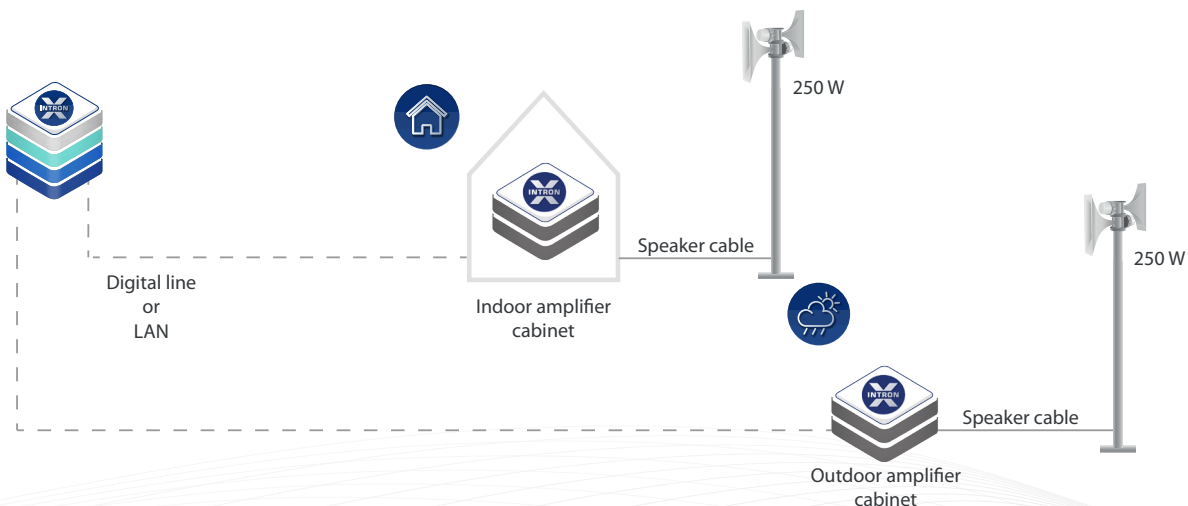

IP AMPLIFIERS OR DIGITAL AMPLIFIERS

HIGH-QUALITY NOTIFICATIONS AND ALARMS

Depending on your requirements, you can choose between IP amplifiers and digital amplifiers.

IP-BASED PA UNIT OF THE NPA SERIES

The multi-channel IP-based PA unit of the NPA series provides two amplifier slots. The amplifier modules are available in two different versions and can be mixed and matched to your preference. A maximum output power of 600 Watts can be reached. The maximum configuration of the NPA allows for the connection of up to 4 siren horns.

Due to the integrated monitoring function of the NPA, you can optionally monitor the circuits of each siren horn. The NPA itself comes with an integrated self-monitoring feature.

The volume of the amplifier channels can be set on the front panel or via the INTRON-X Service Tool XST.



- Modular amplifier modules: up to 600 W output power
- Power supply via power supply unit (100 V AC to 276 V AC) or DC input (42 V DC to 72 V DC)
- High efficiency due to Class-D technology
- Centralized or decentralized installation via Ethernet/IP network
- Integrated amplifier monitoring
- Optional siren monitoring
- Intelligent backup control
- Remote access via the XST anytime you want

DIGITAL POWER AMPLIFIER OF THE DVE SERIES

The digital amplifier of the DVE series is available in two different designs: with 250-W or 500-W output power. For example, up to 4 siren horns can be connected to the 500-W series.

The amplifier can be fed via a power supply unit or via an external DC voltage power supply (48 V / 60 V). It can be flexibly controlled via digital or analog input.

The DVE provides integrated monitoring functions and is permanently monitored for proper operation, short circuit, excess temperature and voltage loss.



- 100-V power amplifier
- 250 W or 2 x 250 W output power
- Power supply via power supply unit (115 V AC or 230 V AC) or DC input (42 V DC to 72 V DC)
- High efficiency due to Class-D technology
- Low requirements for emergency power supply
- High power density
- Integrated amplifier monitoring
- Optional siren monitoring
- Intelligent backup control

INSTALLATION AND MOUNTING ADAPTED TO LOCAL CONDITIONS

FLEXIBLE SETUP OPTIONS

Depending on the conditions and requirements on site, you can mount 1 to 8 siren horns on one mast. Choose between 4 different setups and from a wide range of mounting accessories.

INSTALLATION OF UP TO 8 SIREN HORNS AT THE SAME TIME

For broadcasting messages and tones over wide areas, up to 8 siren horns can be mounted on a mast.

SOUND PROJECTION FROM 0° TO 360° ANGLE

Our modular siren horn design offers you unmatched flexibility in arranging the horns to optimize sound projection. Choose between 4 different setups: a single vertical row (Directional 1), two parallel vertical rows (Directional 2), two opposing vertical rows (Omni-directional 1, setup: 180° angle) or uniform placement around the mast (Omni-directional 2, setup: 360° angle).

- Less installation and cabling effort
- Easy and flexible mounting
- 1 to 8 siren horns mountable to a mast
- 4 different setups available
- Suitable accessories and mounting kits

DIFFERENT SETUPS

The illustration on the left shows the different setups with the maximum number of siren horns mounted on a mast.

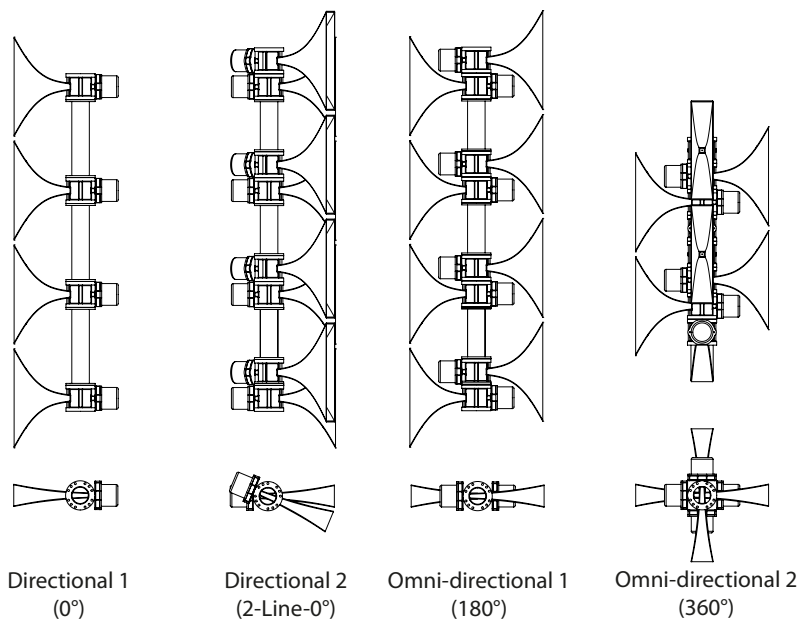

MOUNTING OPTIONS AND SUITABLE ACCESSORIES

Whether it's mounted on rooftops, suitable load-bearing walls, or on a sturdy mast, our system is designed to fit seamlessly into any environment. We offer a comprehensive range of accessories and mounting kits which perfectly complement our siren horns.

INSTALLATION LOCATION AND ACOUSTIC STUDIES

Choose the ideal installation location which best suits your specific site requirements. Consider geographical conditions such as open fields, nearby structures, or obstructive trees to ensure optimal coverage. Planning a PA/GA system can be complex. Our experienced professionals are well-versed in conducting comprehensive acoustic studies. For more information scan the QR code on the right.



DIFFRACTION HORN

OPTIMUM SOUND PROPAGATION

The acoustic siren horn has a so-called diffraction horn which delivers optimum sound propagation.

DIFFRACTION GAP

Our siren horns are not only designed for directional sound projection. They come with an extraordinary feature. The integrated diffraction gap ensures that sound radiates in an almost hemispherical pattern, allowing a single horn to cover a remarkable 180° angle. Simply pair two horns pointing in opposite directions to achieve an impressive 360° sound projection.

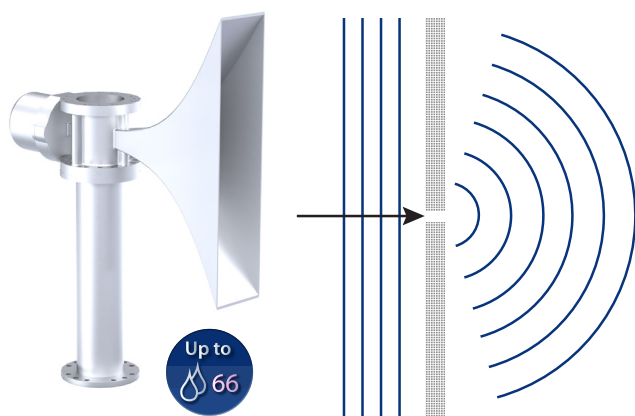

- Seawater-resistant aluminum
- Degree of protection up to IP66
- Sturdy design

HEMISPHERICAL SOUND PROPAGATION

The illustration shows the principle of the diffraction horn's hemispherical sound propagation.

OPTIMUM SOUND COVERAGE OVER WIDE AREAS

Due to the hemispherical sound propagation and the high-power driver with excellent audio quality, wider areas can be covered than with a typical speaker arrangement which is more suitable for directional coverage.

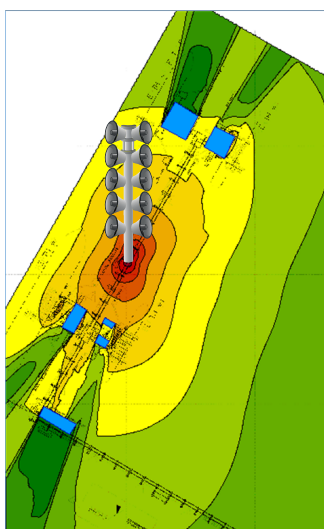

Mast with 10 x 25-W speakers (omni-directional 180° setup)

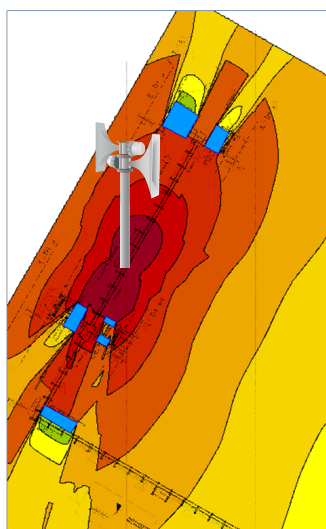

Mast with 2 x 125-W siren horns (omni-directional 180° setup)

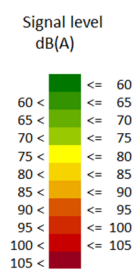

COMPARISON OF SOUND COVERAGE

The illustration shows the significantly higher sound coverage that can be reached with two 125-W siren horns (omni-directional 180° setup) on the right compared to a mast with 10 x 25-W speakers (omni-directional 180° setup) on the left.



TECHNICAL DATA

1 ASH 125

ELECTRICAL DATA

Rated power	125 W
Transformer	100 V / 150 VA
Sound pressure level 125 W / 1 m (3.28 ft) / 1 kHz	133 dB (+/-3 dB)
Effective frequency range	275 Hz to 7,000 Hz

ENVIRONMENTAL REQUIREMENTS AND STANDARDS

Ambient temperature during operation	-50 °C to +70 °C (-58 °F to +158 °F)
Relative humidity (non-condensing)	Max. 95 %
Degree of protection	Up to IP66

MECHANICAL DATA

Housing	Aluminum ALSi7Mg0,35F
Width x height x depth	180 mm x 641 mm x 610 mm (7.09" x 25.24" x 24.02")
Color	Silver
Weight	11 kg (24.25 lbs)
Mounting	Siren mast (Bolt circle diameter 156 mm (6.14"))

ORDER DATA

Type	Description	Type Number
1 ASH 125	Acoustic siren horn 1 x 125 Watts for alarms and voice announcements, for the connection to 100-V PA systems, frequency range up to 7 kHz	208-100-100
1 ASH 125/L8	Acoustic siren horn 1 x 125 Watts for alarms and voice announcements, for the connection to 100-V PA systems, frequency range up to 7 kHz, with pre-wired 8 m connection cable 2 x 1.5 mm ²	208-100-100/L8
1 ASH 125 Siren unit, IP66	Siren unit with 4 siren horns for alarms and voice announcements for the connection to 100-V PA systems, frequency range up to 7 kHz, each horn with 20 m connection cable FireRes 2 x 1.5 mm ²	208-304-100

ACCESSORIES

We provide different accessories and mounting sets for your specific application. Contact us. Our team will be happy to support you.

POSSIBLE APPLICATIONS FOR ALL INDUSTRIES

The acoustic siren horns can be adapted to suit your specific communication and site requirements. They can be deployed in a wide range of applications. Whether they are used to notify people on a large construction site, across an entire industrial plant, or as mobile siren systems. Explore the possibilities. The following examples are only a small selection of the wide range of possible applications.

PLANT-WIDE WARNING & NOTIFICATION BOTH INDOORS AND OUTDOORS

- Wide-area notification across the entire plant or of individual zones

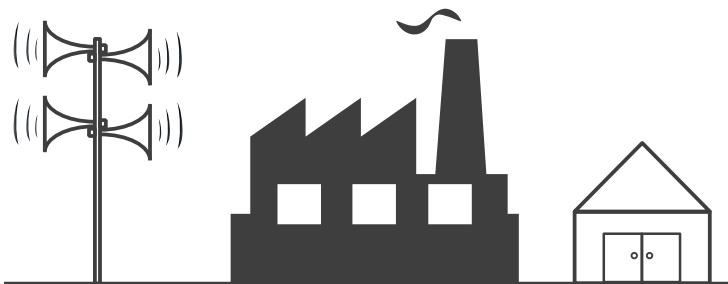

MOBILE SIREN SYSTEMS FOR CONSTRUCTION SITES

- Maximum flexibility with low cabling effort

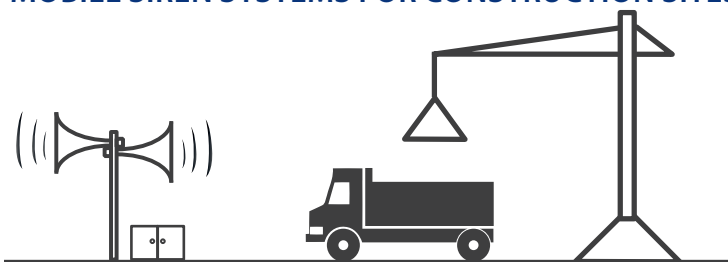

TANK FARMS WITH MARINE LOADING TERMINALS

- Optimum protection against salty air and water contact due to seawater-resistant aluminum

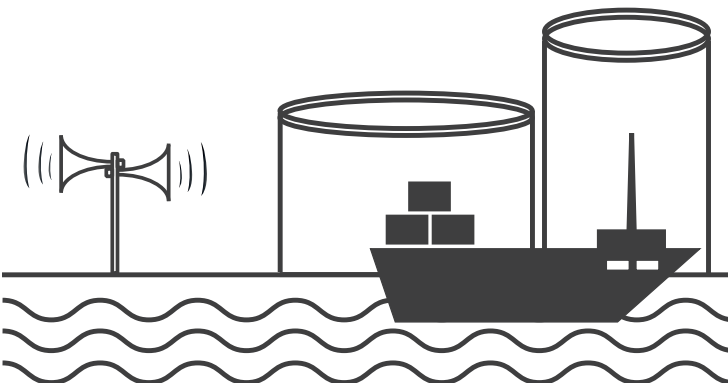

POWER PLANTS WITH COOLING TOWERS

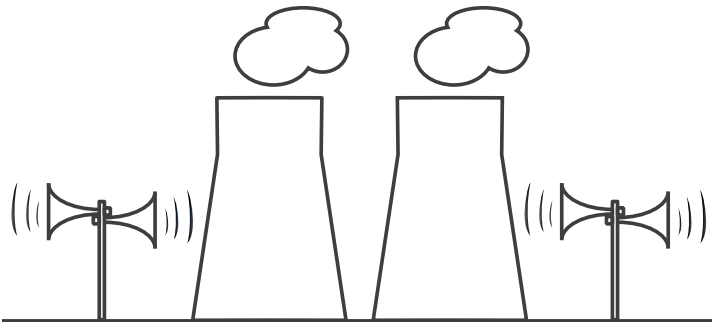

- Clear advantage when it comes to obstacles compared to the high sound absorption of conventional speakers

LARGE CONSTRUCTION SITES

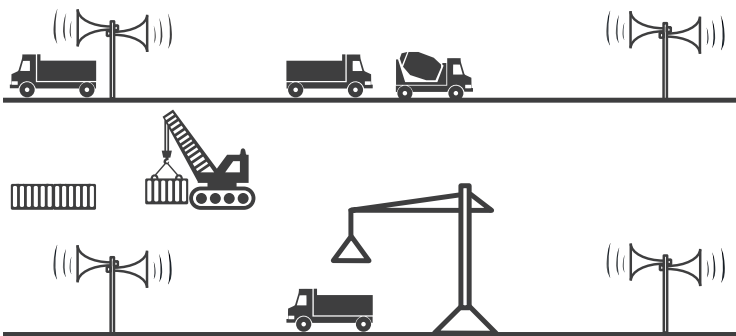

- Optimum sound coverage also in areas with high ambient noise levels

FREIGHT STATIONS

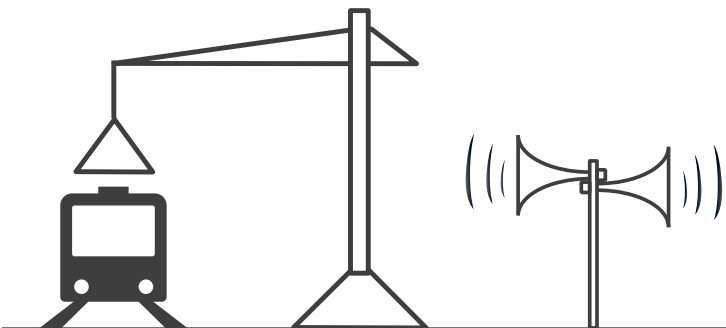

- Giving clear instructions over large distances

ALL BENEFITS AT A GLANCE

Flexible alarm broadcasting
Output of alarms, tones, texts, live announcements

Highest availability

Siren monitoring

Excellent audio quality

Powerful acoustic siren horn

Rugged design

Wide-area coverage

Up to
66

Little installation and maintenance effort

Modular design
Easily expandable